

BELŌNE®

Working Spaces

Areia Studio Concept

AREIA STUDIO CONCEPT



A easy choice

Intemporal e universal. O design universal e o sistema modular permitem adaptá-los a qualquer espaço de escritório.

A AREIA STUDIO CONCEPT não são apenas mesas de trabalho, mas também soluções de armazenamento, reunião e recepção de mobiliário, ideais para quem deseja criar espaços de trabalho individuais / colaborativos e usufruir de um espaço de escritório conveniente.

Timeless and universal. The universal design and the modular system allow you to adapt them to any office space.

AREIA STUDIO CONCEPT is not only desks but also storage, meeting and reception furniture solutions which are ideal for those who want to set up work spaces for individual/collaborative work and to enjoy a convenient office space.

AREIA STUDIO CONCEPT



Privacy and concentration

A privacidade é importante para ajudar os funcionários a manter a concentração. Escolha os nossos painéis mais adequados para eles. Existem duas opções que podem atender às suas necessidades: o tecido acústico do Gabriel ou as divisórias em melamina.

It's important some privacy to help the workers maintain their concentration. Choose our panels that are most suitable for them. There are two options that can suit your needs: acoustic fabric from Gabriel or melamine partitions.



CHOOSE YOUR COLOURS

Siga as nossas cores minimalistas ou simplesmente escolha as combinações de cores que se adequem ao seu espaço do seu escritório.

Follow our minimalist colors or simply choose color combinations which will suit your office space.

**AREIA
STUDIO
CONCEPT**



AREIA STUDIO CONCEPT



INSPIRATION

PRETO, BRANCO ou a sua cor de SONHO.

BLACK, WHITE or your DREAM Color



Workstation with Sliding Desktop

No escritório, muitas vezes temos que lidar com múltiplos cabos, assim como pequenos locais de trabalho. Escolha a estação de trabalho AREIA com uma área de empurrar/puxar. O tabuleiro de cabos, o acesso à unidade de energia e o manuseamento dos cabos serão muito mais convenientes, sendo estas mesas baseadas num princípio muito simples: para acessar a bandeja de cabos, puxe a mesa em direção a você; Se quiser esconder os cabos, simplesmente basta empurrar a área de trabalho ligeiramente.

In the office, we often have to deal with multiple cables and small workplace. Choose AREIA workstation with a push/pull desktop. The arrangement of the cable tray, the access to the power unit and cable management will be much more convenient. These desks are based on a very simple principle: to access the cable tray, pull the desktop toward yourself; if you want to conceal the cables, then simply push the desktop slightly.





**AREIA
STUDIO
CONCEPT**

MESAS | TABLES

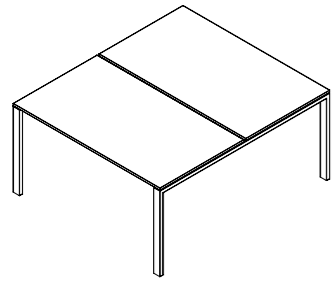

1400x1620x740

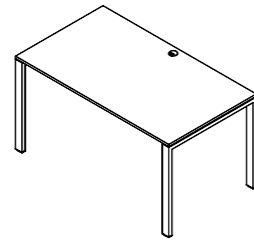

1400x800x740

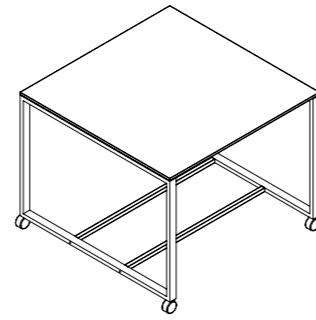

1400x1400x1100

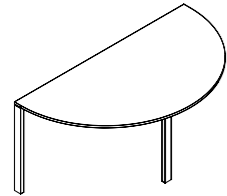

1620x800

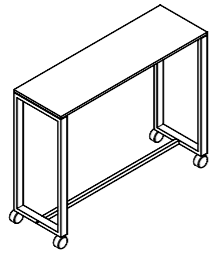

1400x450x1100

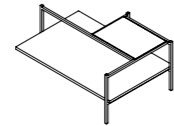

900x600x400



600x600x450

Assentos | Seats

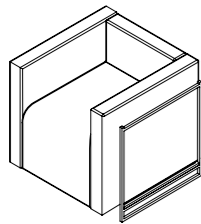

800x800x800

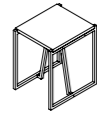

300x376x450

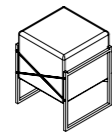

366x366x450



500x500x890

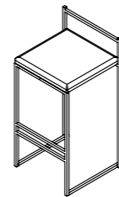

420x420x750

Armários | Cabinets

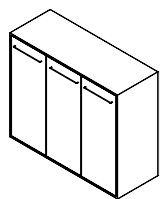

1200x450x740

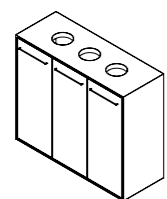

1200x450x740

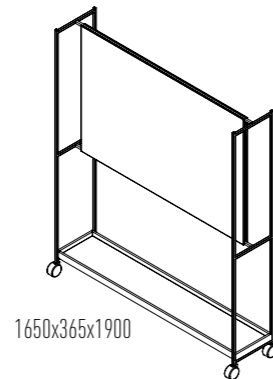

1650x365x1900

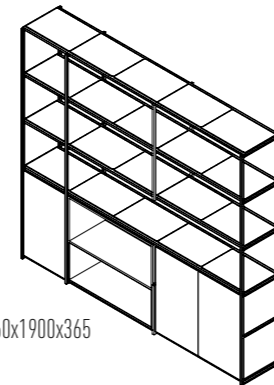

2060x1900x365

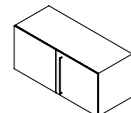

800x350x350

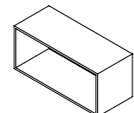

800x350x350

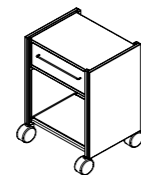

450x365x600

Acessórios | Accessories

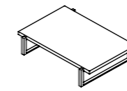

450x366x120

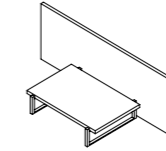

1000x386x450

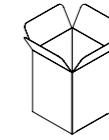

220x220x400

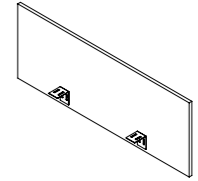

1200x4500x20

Notas | Notes | Notas

AREIA STUDIO CONCEPT

Belone reserva o direito de modificar e melhorar as características dos produtos descritos neste catálogo, para assim poder satisfazer as exigências do mercado. Embora as cores sejam reproduzidas fielmente, alguns produtos podem ser diferentes dos originais. Para uma referência mais precisa sobre os detalhes dos produtos, aconselha-se o uso do catálogo técnico.

Belone reserves the right to modify and improve the characteristics of the products shown in this catalogue in order to meet market requirements. Although reproduced as faithfully as possible, the product colours illustrated may differ from those of actual products. For accurate information on detailed product specifications, please use the technical catalogue.

BELONE®
Working Spaces

Belone.pt